

CUTTING TONGS

INSTALLATION SIZE ZK1036

▶ PRODUCT SPECIFICATIONS



▶ INCLUDED IN DELIVERY

	1 [piece] Locking nut C093614159
---	--

▶ RECOMMENDED ACCESSORIES

ENERGY SUPPLY

	GVM5 Straight Fittings - Quick Connect Style
---	--

	WVM5 Angled Fittings - Quick Connect Style
---	--

SENSORS

	KHD36 Sensor holder
---	-------------------------------

	MFS02-K-KHC-P1-PNP Magnetic field sensor straight, cable 5 m
---	--

	MFS02-S-KHC-P1-PNP Magnetic field sensor straight, cable 0.3 m - M8 connector
---	---

CONNECTIONS / OTHER

	BK1036-01 Cutting Insert 25° For Plastics
---	---

	BK1036-02 Cutting Insert 40° For Plastics
---	---

	BK1036-03 Cutting Insert 0° For Plastics
---	--

	BK1036-04 Cutting Tong For Plastics
---	---

	BK1036-05 Cutting Insert 0° For Steel
---	---

► Technical data	
Order no.	ZK1036
Stroke per jaw [°]	5
Gripping moment in closing [Nm]	40
Closing time [s]	0.04
Opening time [s]	0.15
Operating pressure min. [bar]	2
Operating pressure max. [bar]	6
Nominal operating pressure [bar]	6
Operating temperature min. [°C]	5
Operating temperature max. [°C]	+80
Air volume per cycle [cm³]	9.2
Weight [kg]	0.13
Possible cutting diameters	
possible cut-Ø max. plastics [mm]	4
possible cut-Ø max. hard-plastic [mm]	2.6
possible cut-Ø max. copper [mm]	1.6
possible cut-Ø max. steel [mm]	1
possible cut-Ø max. piano wire [mm]	0.5

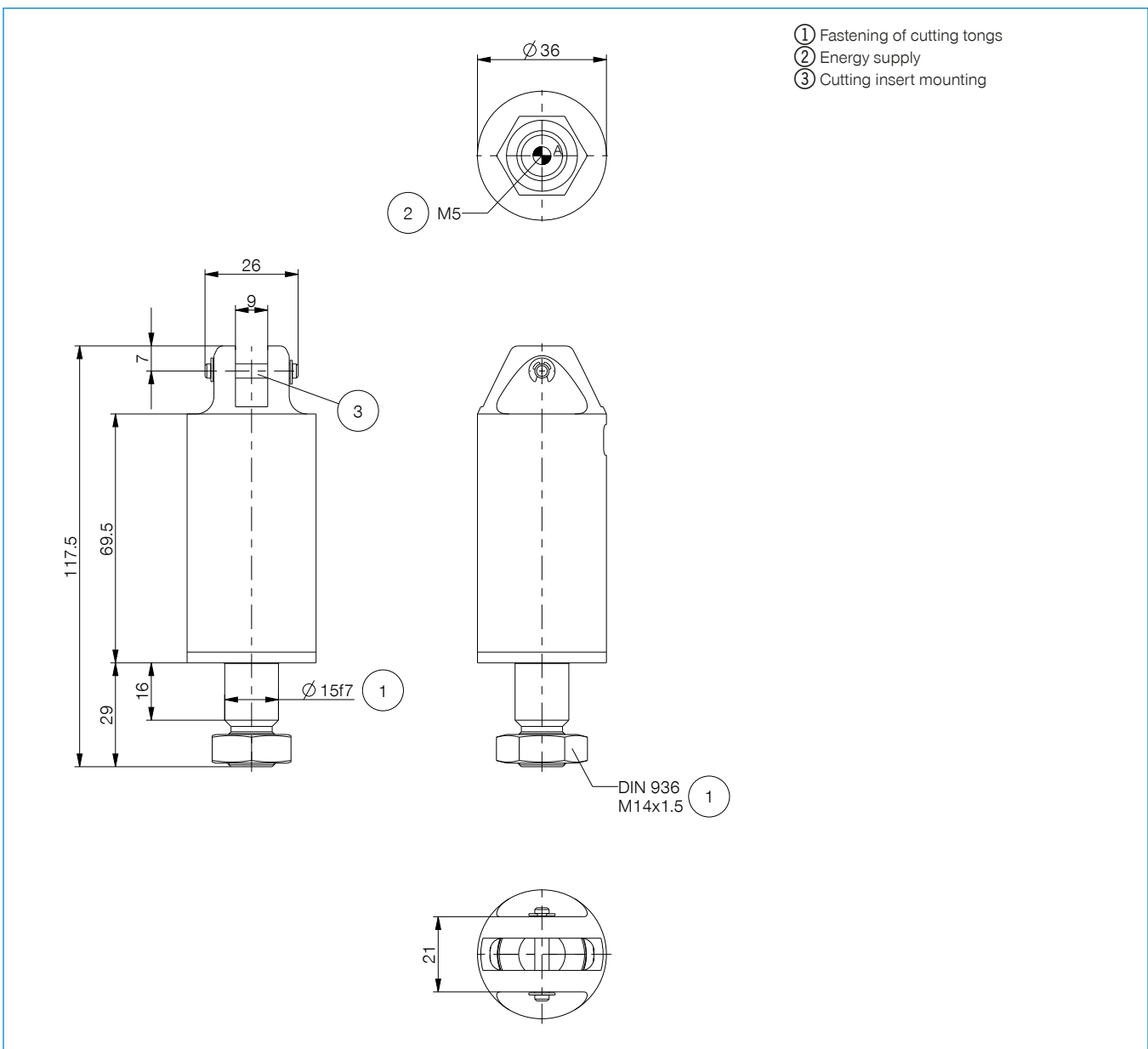

CUTTING TONGS

ZK1000 SERIES CUTTING INSERTS

▶ CUTTING INSERTS FOR ZK1030

BK1030-01

Cutting Insert 15° for plastics

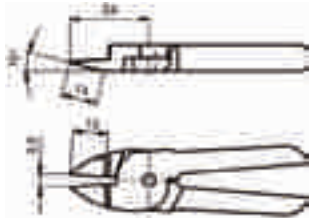

BK1030-02

Cutting Insert 40° For Plastics

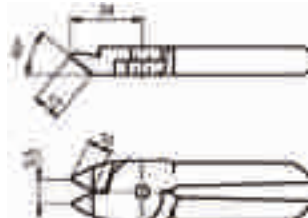

BK1030-03

Cutting Insert 0° For Plastics

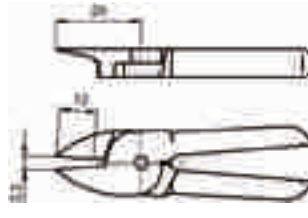

BK1030-04

Cutting Tong For Plastics

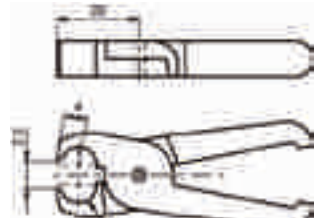

BK1030-05

Cutting Insert 0° For Steel

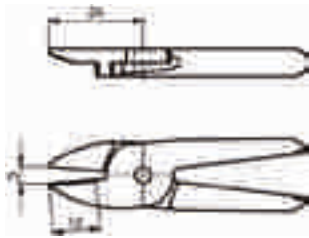

BK1030-06

Cutting Insert 25° For Steel

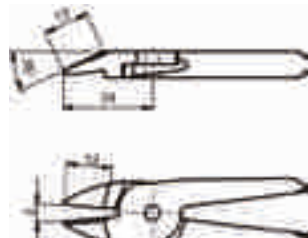

BK1030-07

Carbide cutting insert 0° for steel

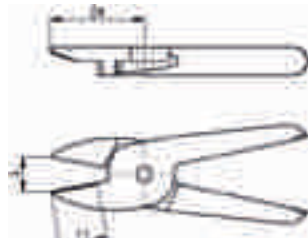

BK1030-08

Carbide Cutting Insert 25° For Steel

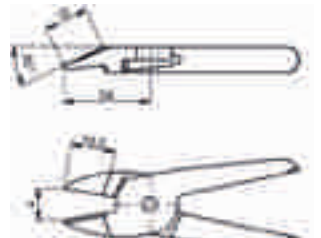

▶ CUTTING INSERTS FOR ZK1036

BK1036-01

Cutting Insert 25° For Plastics

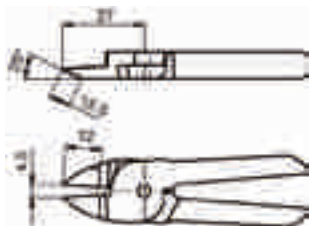

BK1036-02

Cutting Insert 40° For Plastics

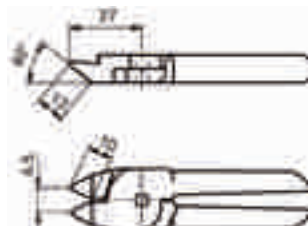

BK1036-03

Cutting Insert 0° For Plastics

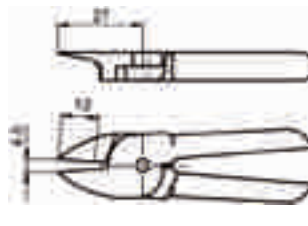

BK1036-04

Cutting Tong For Plastics

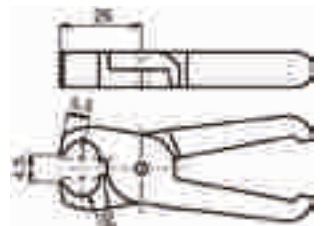

BK1036-05

Cutting Insert 0° For Steel

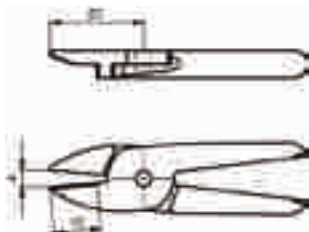

BK1036-06

Cutting Insert 25° For Steel

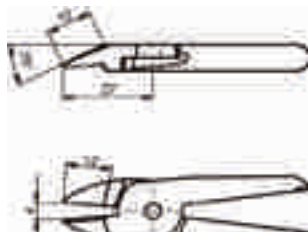

BK1036-07

Carbide cutting insert 0° for steel

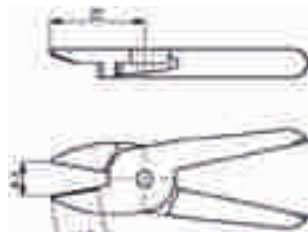

BK1036-08

Carbide Cutting Insert 25° For Steel

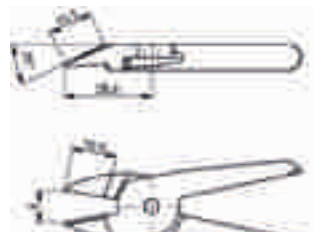

▶ CUTTING INSERTS FOR ZK1045

BK1045-01

Cutting Insert 15° for plastics

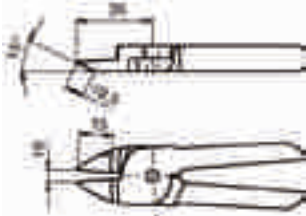

BK1045-02

Cutting Insert 40° For Plastics

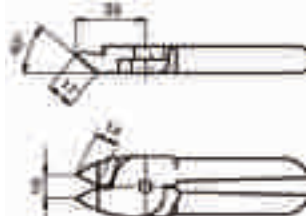

BK1045-03

Cutting Insert 0° For Plastics

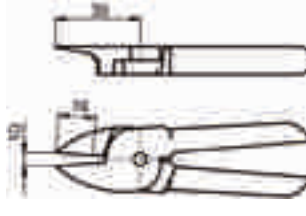

BK1045-04

Cutting Tong For Plastics

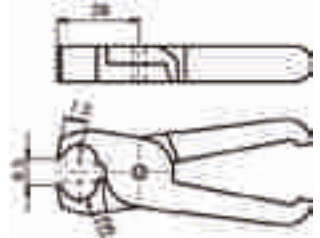

BK1045-05

Cutting Insert 0° For Steel

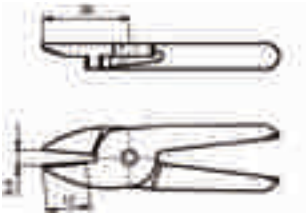

BK1045-06

Cutting Insert 30° For Steel

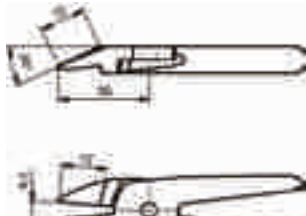

BK1045-07

Carbide cutting insert 0° for steel

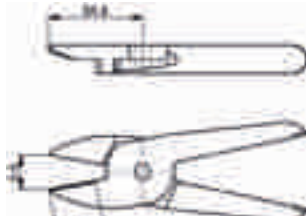

BK1045-08

Carbide Cutting Insert 35° For Steel

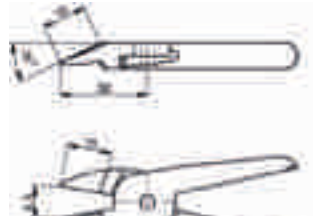

▶ CUTTING INSERTS FOR ZK1065

BK1065-01

Cutting Insert 15° for plastics

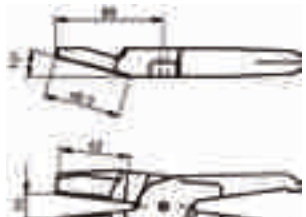

BK1065-02

Cutting Insert 0° For Plastics

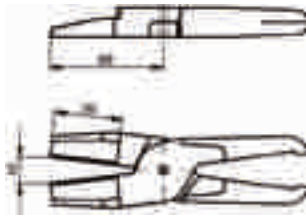

BK1065-03

Cutting Insert 30° For Plastics

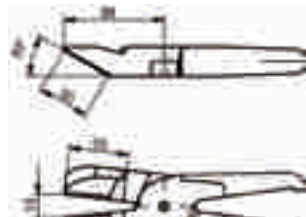

BK1065-04

Cutting Tong For Plastics

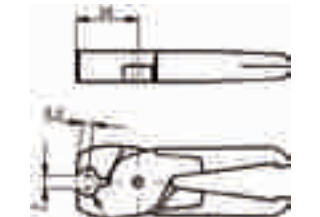

BK1065-05

Cutting Insert 0° For Steel

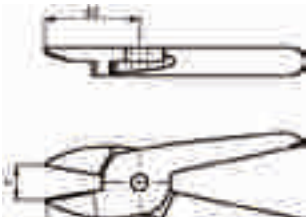

BK1065-06

Cutting Insert 30° For Steel

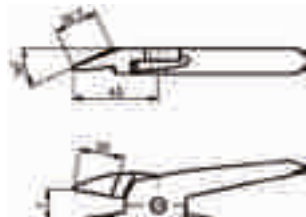

BK1065-07

Carbide cutting insert 0° for steel

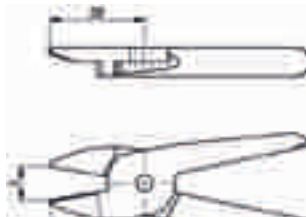

BK1065-08

Carbide Cutting Insert 40° For Steel

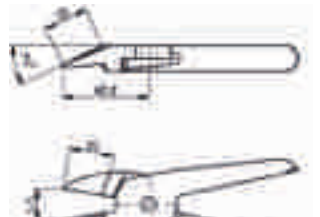

CUTTING TONGS

SERIES ZK1000

▶ PRODUCT ADVANTAGES



▶ Extremely lightweight

This light weight generally allows the use of a smaller moving axis, reducing the overall costs of the application in the process

▶ Integrated magnetic field sensing

One of the few cutting tongs on the market that can have its position queried and transferred to the control system with process reliability

▶ Decide for yourself!

Sprue or steel wire: The variety of cutting geometries and materials ensure you always find the correct cuttings

▶ SERIES CHARACTERISTICS

Installation size

ZK10XX

 5 million maintenance-free cycles (max.)	●
 Spring opening O	●
 Magnetic field sensor	●
 IP30	●



► BENEFITS IN DETAIL



- ① **Cutting insert**
 - flexible applicable due to specific cutting geometry
- ② **Return spring**
 - to open the cuttings
- ③ **Mounting clamp**
 - mounting and positioning of magnetic field sensors
- ④ **Magnetic field sensor**
 - for position sensing
- ⑤ **Drive**
 - single-acting pneumatic cylinder
- ⑥ **Housing**
 - Hard-coated aluminum alloy
- ⑦ **Mounting and positioning**
 - via fit, thread and lock nut
- ⑧ **Energy supply**

► TECHNICAL DATA

Installation size	Stroke [°]	Gripping moment [Nm]	Weight [kg]	IP class
ZK1030	4.25	14	0.08	IP30
ZK1036	5	40	0.13	IP30
ZK1045	8.5	98	0.24	IP30
ZK1065	13	400	0.67	IP30

► FURTHER INFORMATION IS AVAILABLE ONLINE



All information just a click away at: www.zimmer-group.com. Find data, illustrations, 3D models and operating instructions for your installation size using the order number for your desired product. Quick, clear and always up-to-date.