

TOOL CHANGERS

SERIES WWR

▶ PRODUCT ADVANTAGES

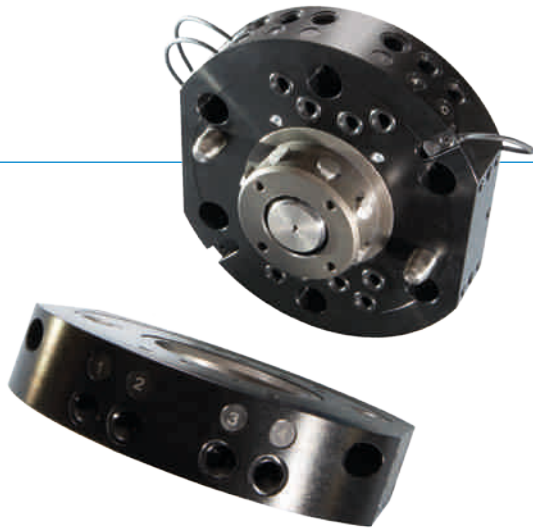

▶ **Secure hold during pressure drop**

A redundant system, created by the combination of spring accumulator and a self locking mechanism, guarantees a safe machine

▶ **Extremely flat design**

This structure reduces the moment load for your robot to a minimum and makes it possible to use smaller and more affordable sizes

▶ **Inexhaustible variety of media transfer systems**

No matter which medium you would like to transmit, we will draw from our wealth of experience in implementing projects and find a solution to suit your needs!

▶ THE BEST PRODUCT FOR YOUR APPLICATION



▶ **Our products welcome the challenge!**

Extreme conditions, all over the world—our tried and tested components and systems give you endless possibilities.

Find the best product for your specific use:

www.zimmer-group.com

► BENEFITS IN DETAIL

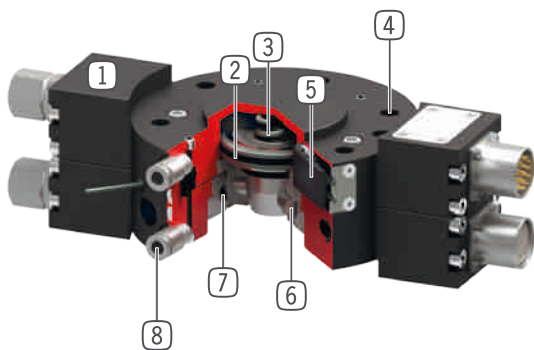

- ① **Energy element**
- included in scope of delivery
- ② **Drive**
- double-acting pneumatic cylinder
- ③ **Integrated spring**
- energy storage in case of drop in pressure
- ④ **Robot flange**
- partial mounting circle in accordance with EN ISO 9409-1
- ⑤ **Piston position sensing**
- via magnetic field sensors
- ⑥ **Locking bolt**
- adapted to the clamping sleeve
- ⑦ **Locking sleeve**
- high moment capacity
- ⑧ **Integrated air feed-through**
- air / vacuum transfer from fix to loose part, hoseless control possible

► FURTHER INFORMATION IS AVAILABLE ONLINE



► Technical Information

All information just a click away at: www.zimmer-group.com

Find data, illustrations, 3D models and operating instructions for your installation size using the order number for your desired product.

Quick, clear and always up-to-date.



TOOL CHANGERS

INSTALLATION SIZE WWR50

▶ PRODUCT SPECIFICATIONS



▶ Forces and moments

Shows static forces and moments which may impact on the tool changer.

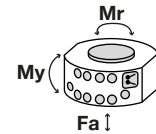

Mr [Nm]	100
My [Nm]	105
Fa [N]	4000

▶ INCLUDED IN DELIVERY



O-Ring

COR0025100

▶ RECOMMENDED ACCESSORIES



Straight Fittings - Quick Connect Style

GVM5



Angled Fittings - Quick Connect Style

WVM5



Piston position sensing

ZUB088928



Inductive Proximity Switch Cable 0,3 m - Connector M8

NJR04-E2SK



Energy Elements see page 48

▶ RECOMMENDED ACCESSORY STORAGE STATION



Storage station

ALSR1-50-B



Inductive proximity switch - Cable 5 m

NJ5-E2



Inductive Proximity Switch Cable 0,3 m - Connector M8

NJ5-E2SK

► **Technical Data***

Order no.	WWR50F-B	WWR50L-B
Connecting flange according EN ISO 9409-1	TK 50	TK 50
Recommended handling weight [kg]	30	-
Pneumatic energy transfer [Quantity]	4	4
Electrical energy transfer	optional	optional
Hydraulic energy transfer	optional	optional
Self locking mechanism when locking	mechanical	mechanical
Locking stroke [mm]	0.3	-
Repetition accuracy in Z [mm]	0.01	-
Repetition accuracy in X, Y [mm]	0.02	-
Joining force [N]	50	-
Release force [N]	30	-
Offset at coupling max. in X,Y [mm]	1.5	1.5
Operating pressure [bar]	4 ... 10	4 ... 10
Operating temperature [°C]	5 ... +80	5 ... +80
Air volume per cycle [cm ³]	3	-
Moment of inertia [kg/cm ²]	0.8	0.7
Weight [kg]	0.19	0.15

*All data measured at 6 bar

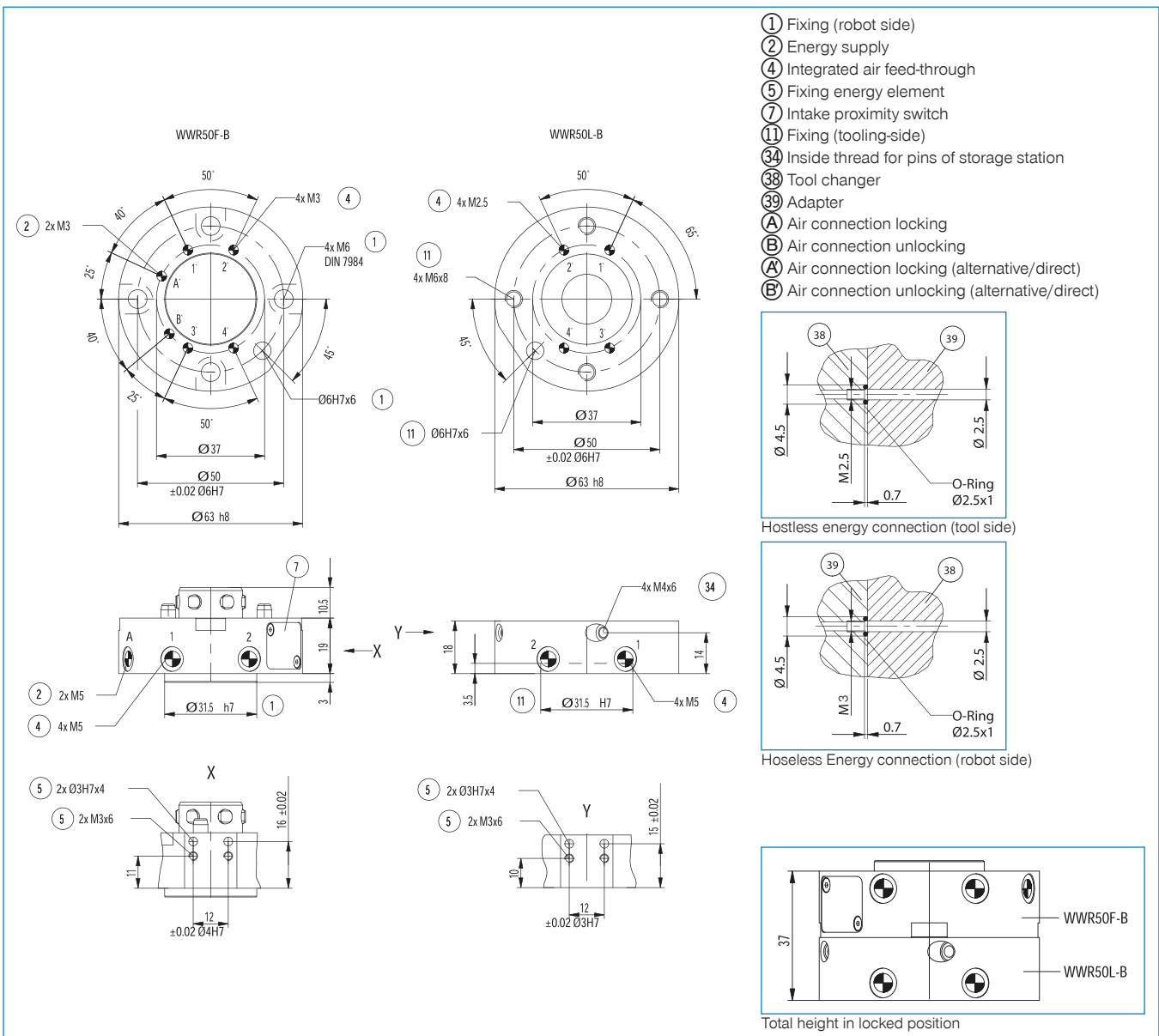

ENERGY ELEMENTS FOR TOOL CHANGER

SIZES WWR40 / WWR50

▶ PRODUCT SPECIFICATIONS

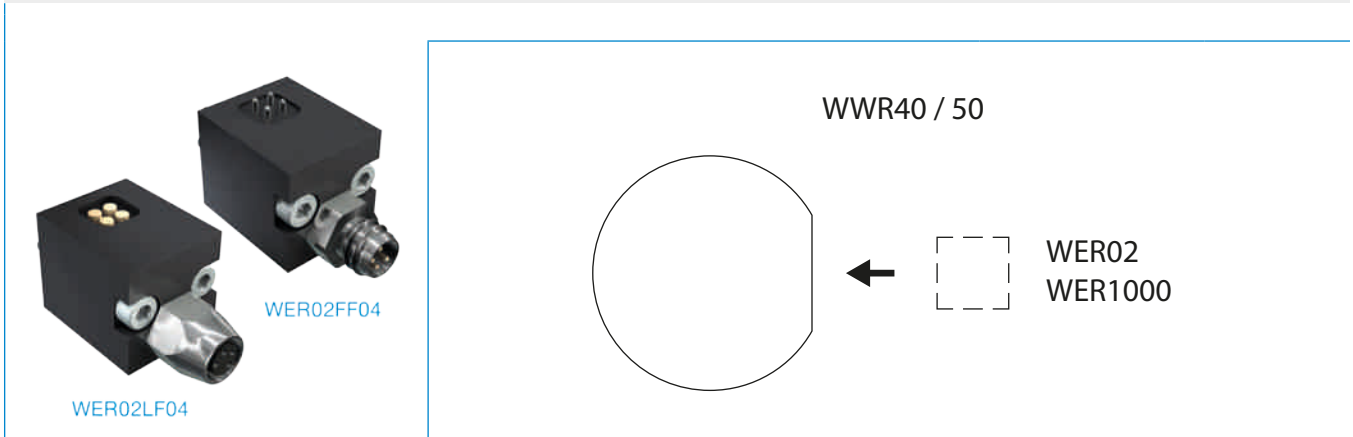

▶ ELECTRICAL

▶ Technical Data

Order no.	WER02FS04	WER02LS04	WER02FF04	WER02LF04	WER1000FSI20-05	WER1000LSI20-05	WER1000FIL01-00-A	WER1000LIL01-00-A
compatible with	Fix part	Loose part	Fix part	Loose part	Fix part	Loose part	Fix part	Loose part
Connection type	Plug-in Connector	Plug-in Connector	Spring contact	Spring contact	FST	FST	-	-
Round Connector [Straight] *	KAG500B4	KAG500S4	KAG500B4	KAG500S4	-	-	-	-
Round Connector [Angle] *	KAW500B4	KAW500S4	KAW500B4	KAW500S4	-	-	-	-
Fixing thread	M8	M8	M8	M8	-	-	M12	M12
No. of contacts	4	4	4	4	20	20	-	-
Nominal current [A]	4	4	3	3	3	3	-	-
Supply voltage [V AC]	60	60	60	60	60	60	-	-
Supply voltage [V DC]**	75	75	75	75	75	75	-	-
Weight [kg]	0.03	0.03	0.03	0.03	0.02	0.02	0.036	0.038
Connection type	Male	Socket	Male	Socket	Customizable	Customizable	Male	Socket

* als Zubehör erhältlich see page 63

** Specifications for on-site grounding, 60V without grounding





PLUG-IN CONNECTOR FOR ENERGY ELEMENTS

SUITABLE FOR WER201 / WER02 / WER03 / WER3000





▶ PLUG-IN CONNECTOR FOR ENERGY ELEMENTS WER201 / WER02 / WER03

Order no.	▶ Technical Data							
	KAG500B4	KAW500B4	B8-G-4	B8-W-4	KAG500S4	KAW500S4	S8-G-4	S8-W-4
Fixing thread	M8	M8	M8	M8	M8	M8	M8	M8
No. of contacts	4	4	4	4	4	4	4	4
Cable length [m]	5	5	-	-	5	5	-	-
Cable-Ø [mm]	4.3	4.3	-	-	4.3	4.3	-	-
Cable sheath material	PUR	PUR	-	-	PUR	PUR	-	-
Bend radius	10xØ	10xØ	-	-	10xØ	10xØ	-	-
Protection to IEC 60529	IP67	IP67	IP67	IP67	IP67	IP67	IP67	IP67
Connection type	Female	Female	Female	Female	Connector	Connector	Connector	Connector
Version [Type]	Straight	Angle	Straight	Angle	Straight	Angle	Straight	Angle

▶ ROUND PLUG FOR WER3000

Order no.	▶ Technical Data			
	RSTVLM23G06B-B	RSTVLM23W06B-B	RSTVLM23G06S-B	RSTVLM23W06S-B
Fixing thread	M23	M23	M23	M23
No. of contacts	6	6	6	6
Protection to IEC 60529	IP67	IP67	IP67	IP67
Connection type	Socket	Socket	Male	Male
				

Order no.	▶ Technical Data			
	RSTVLM23G08B-B	RSTVLM23W08B-B	RSTVLM23G08S-B	RSTVLM23W08S-B
Fixing thread	M23	M23	M23	M23
No. of contacts	8	8	8	8
Protection to IEC 60529	IP67	IP67	IP67	IP67
Connection type	Socket	Socket	Male	Male
				

Order no.	▶ Technical Data			
	RSTVSM23G12B-B	RSTVSM23W12B-B	RSTVSM23G12S-B	RSTVSM23W12S-B
Fixing thread	M23	M23	M23	M23
No. of contacts	12	12	12	12
Protection to IEC 60529	IP67	IP67	IP67	IP67
Connection type	Socket	Socket	Male	Male
				

Order no.	▶ Technical Data			
	RSTVSM23G19B-B	RSTVSM23W19B-B	RSTVSM23G19S-B	RSTVSM23W19S-B
Fixing thread	M23	M23	M23	M23
No. of contacts	19	19	19	19
Protection to IEC 60529	IP67	IP67	IP67	IP67
Connection type	Socket	Socket	Male	Male
	