

TOOL CHANGERS

SERIES WWR

▶ PRODUCT ADVANTAGES

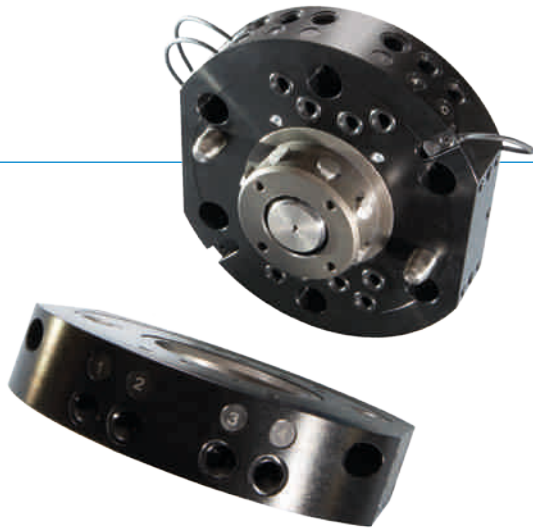

▶ **Secure hold during pressure drop**

A redundant system, created by the combination of spring accumulator and a self locking mechanism, guarantees a safe machine

▶ **Extremely flat design**

This structure reduces the moment load for your robot to a minimum and makes it possible to use smaller and more affordable sizes

▶ **Inexhaustible variety of media transfer systems**

No matter which medium you would like to transmit, we will draw from our wealth of experience in implementing projects and find a solution to suit your needs!

▶ THE BEST PRODUCT FOR YOUR APPLICATION



▶ **Our products welcome the challenge!**

Extreme conditions, all over the world—our tried and tested components and systems give you endless possibilities.

Find the best product for your specific use:

www.zimmer-group.com

► BENEFITS IN DETAIL

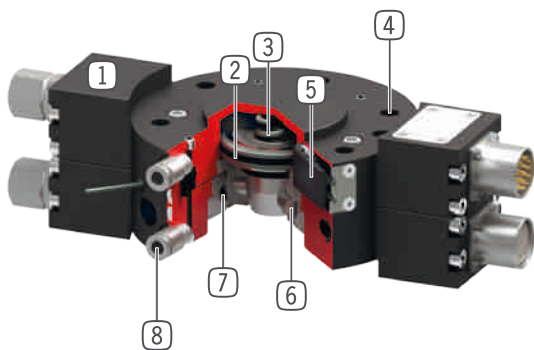

- ① **Energy element**
- included in scope of delivery
- ② **Drive**
- double-acting pneumatic cylinder
- ③ **Integrated spring**
- energy storage in case of drop in pressure
- ④ **Robot flange**
- partial mounting circle in accordance with EN ISO 9409-1
- ⑤ **Piston position sensing**
- via magnetic field sensors
- ⑥ **Locking bolt**
- adapted to the clamping sleeve
- ⑦ **Locking sleeve**
- high moment capacity
- ⑧ **Integrated air feed-through**
- air / vacuum transfer from fix to loose part, hoseless control possible

► FURTHER INFORMATION IS AVAILABLE ONLINE



► Technical Information

All information just a click away at: www.zimmer-group.com

Find data, illustrations, 3D models and operating instructions for your installation size using the order number for your desired product.

Quick, clear and always up-to-date.



TOOL CHANGERS

INSTALLATION SIZE WWR125

▶ PRODUCT SPECIFICATIONS



▶ Forces and moments

Shows static forces and moments which may impact on the tool changer.

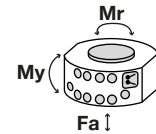

Mr [Nm]	1500
My [Nm]	1700
Fa [N]	26000

▶ INCLUDED IN DELIVERY



O-Ring

COR0070150

▶ RECOMMENDED ACCESSORIES



Straight Fittings - Quick Connect Style

GV1-8X8



Angled Fittings - Quick Connect Style

WV1-8X8



Piston position sensing

ZUB088923



Inductive Proximity Switch
Cable 0,3 m - Connector
M8

NJR04-E2SK



Energy Elements see
page 52

▶ RECOMMENDED ACCESSORY STORAGE STATION



Base module for storage
station

ALSR13125



Inductive proximity switch
- Cable 5 m

NJ8-E2



Inductive proximity switch
- Connector M8

NJ8-E2S

► Technical Data*

Order no.	WWR125F-B	WWR125L-B
Connecting flange according EN ISO 9409-1	TK 125	TK 125
Recommended handling weight [kg]	230	-
Pneumatic energy transfer [Quantity]	10	10
Electrical energy transfer	optional	optional
Hydraulic energy transfer	optional	optional
Self locking mechanism when locking	mechanical	mechanical
Locking stroke [mm]	1.3	-
Repetition accuracy in Z [mm]	0.01	-
Repetition accuracy in X, Y [mm]	0.02	-
Joining force [N]	150	-
Release force [N]	80	-
Offset at coupling max. in X,Y [mm]	2.85	2.85
Operating pressure [bar]	4 ... 10	4 ... 10
Operating temperature [°C]	5 ... +80	5 ... +80
Air volume per cycle [cm ³]	80	-
Moment of inertia [kg/cm ²]	48	42
Weight [kg]	2.1	1.45

*All data measured at 6 bar

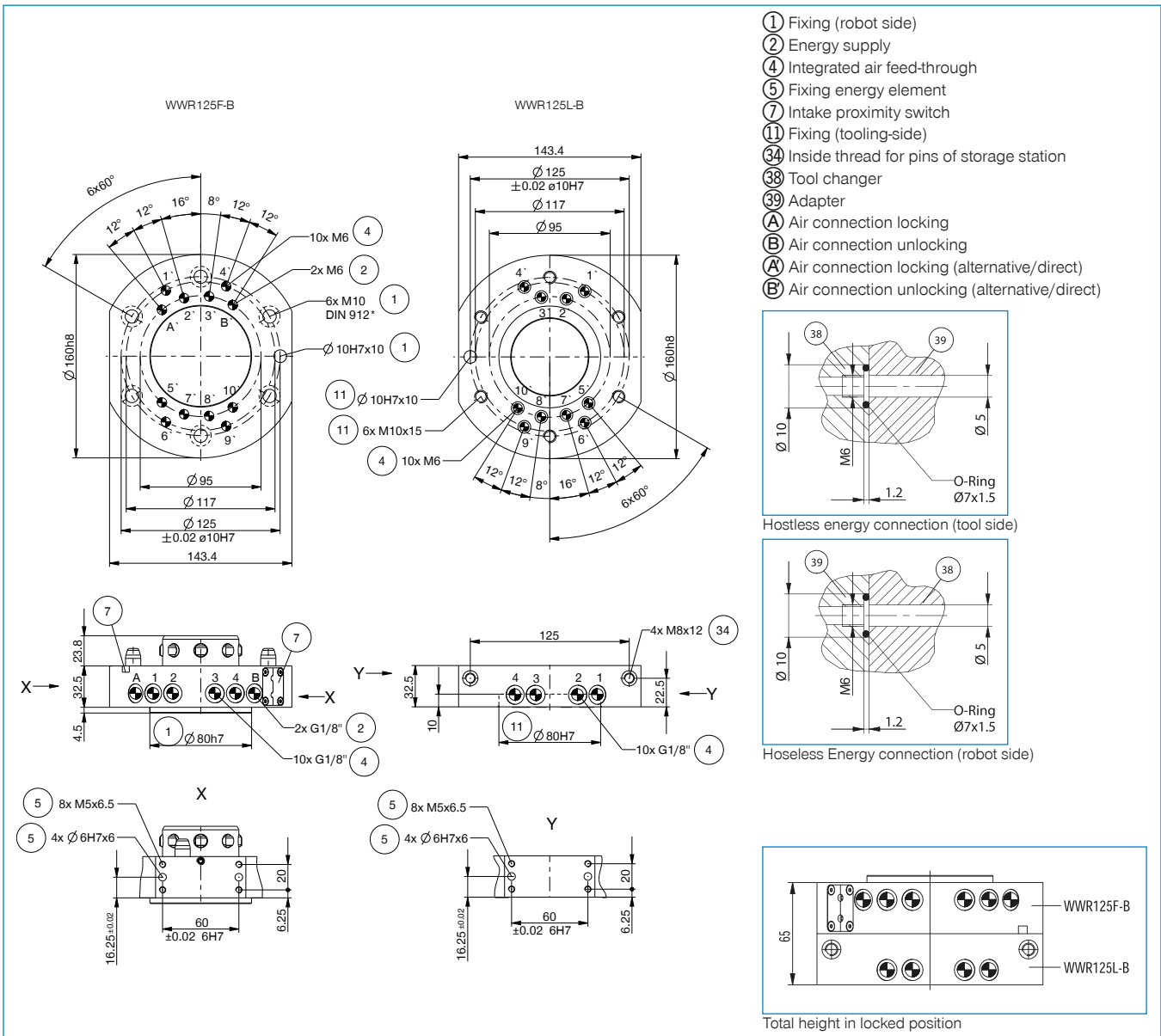

ENERGY ELEMENTS FOR TOOL CHANGER

SIZES WWR125 / WWR160

PRODUCT SPECIFICATIONS

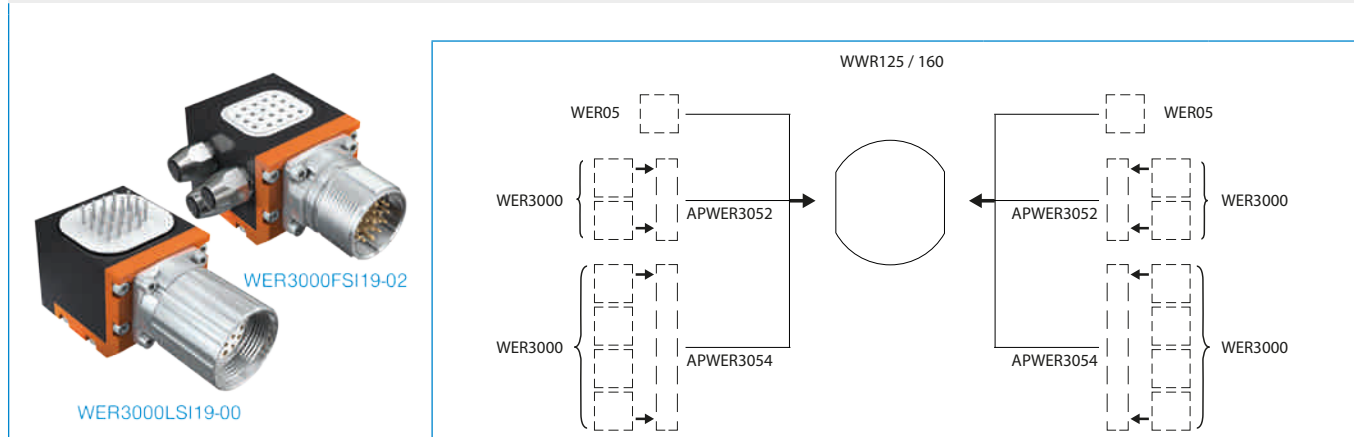

FLUIDIC

Technical Data

Order no.	WER05FH2	WER05LH2	WER05FH2D	WER05LH2D
compatible with	Fix part	Loose part	Fix part	Loose part
Fixing thread	G1/4"	G1/4"	G1/4"	G1/4"
Number of fluid couplings	2	2	2	2
Operating pressure max. [bar]*	350	350	350	350
Operating pressure max. [bar]**	15	15	350	350
Weight [kg]	0.30	0.30	0.30	0.30

* At pressures of approximately 50 bar and higher, there must be external locking of the elements.

** Observe coupling force

Technical Data

Order no.	WER3000FPL02-03	WER3000LPL02-03	WER3000FPL01-04	WER3000LPL01-04
compatible with	Fix part	Loose part	Fix part	Loose part
Fixing thread	G1/4"	G1/4"	G3/8"	G3/8"
Number of fluid couplings	2	2	1	1
Operating pressure [bar]	-0.6 ... 10	-0.6 ... 10	-0.6 ... 10	-0.6 ... 10
Weight [kg]	0.13	0.13	0.13	0.13

ELECTRICAL

Technical Data

Order no.	WER3000FLA06-00	WER3000LLA06-00	WER3000FLA08-00	WER3000LLA08-00	WER3000FS12-00	WER3000LS12-00
compatible with	Fix part	Loose part	Fix part	Loose part	Fix part	Loose part
Connection type	Plug-in Connector	Plug-in Connector	Plug-in Connector	Plug-in Connector	Plug-in Connector	Plug-in Connector
Round Connector [Straight] *	RSTVLM23G06B-B	RSTVLM23G06S-B	RSTVLM23G08B-B	RSTVLM23G08S-B	RSTVSM23G12B-B	RSTVSM23G12S-B
Round Connector [Angle] *	RSTVLM23W06B-B	RSTVLM23W06S-B	RSTVLM23W08B-B	RSTVLM23W08S-B	RSTVSM23W12B-B	RSTVSM23W12S-B
Fixing thread	M23	M23	M23	M23	M23	M23
No. of contacts	5+PE	5+PE	(3+PE) / 4	(3+PE) / 4	12	12
Nominal current [A]	15	15	15/6	15/6	6	6
Supply voltage [V AC]	600	600	600/150	600/150	150	150
Weight [kg]	0.35	0.41	0.35	0.40	0.12	0.15
Connection type	Male	Socket	Male	Socket	Male	Socket

* als Zubehör erhältlich see page 63

▶ ELECTRICAL

Order no.	▶ Technical Data			
	WER3000FSI19-00	WER3000LSI19-00	WER3000FSI19-09	WER3000LSI19-09
compatible with	Fix part	Loose part	Fix part	Loose part
Connection type	Plug-in Connector	Plug-in Connector	Spring contact	Spring contact
Round Connector [Straight] *	RSTVSM23G19B-B	RSTVSM23G19S-B	RSTVSM23G19B-B	RSTVSM23G19S-B
Round Connector [Angle] *	RSTVSM23W19B-B	RSTVSM23W19S-B	RSTVSM23W19B-B	RSTVSM23W19S-B
Fixing thread	M23	M23	M23	M23
No. of contacts	19	19	19	19
Nominal current [A]	6	6	3	3
Supply voltage [V AC]	150	150	60	60
Weight [kg]	0.13	0.15	0.13	0.15
Connection type	Male	Socket	Male	Socket

*als Zubehör erhältlich see page 63

▶ ELECTRICAL + 3 CONNECTION OPTIONS FOR WWR SENSORS

Order no.	▶ Technical Data		
	WER3000FSI19-01	WER3000FSI19-02	WER3000LSI19-00
compatible with	Fix part	Fix part	Loose part
Connection type	Plug-in Connector	Plug-in Connector	Plug-in Connector
Round Connector [Straight] *	RSTVSM23G19B-B	RSTVSM23G19B-B	RSTVSM23G19S-B
Round Connector [Angle] *	RSTVSM23W19B-B	RSTVSM23W19B-B	RSTVSM23W19S-B
Fixing thread	M23	M23	M23
No. of contacts	14+5 Sensoric	14+5 Sensoric	19
Nominal current [A]	6	6	6
Supply voltage [V AC]	150	150	150
Sensor linkage	Left	Right	-
Weight [kg]	0.16	0.16	0.15
Connection type	Male	Male	Socket

*als Zubehör erhältlich see page 63

▶ FIELDBUS

Order no.	▶ Technical Data					
	WER3000FPN01-00	WER3000LPN01-00	WER3000FPB01-00	WER3000LPB01-00	WER3000FIL01-00	WER3000LIL01-00
compatible with	Fix part	Loose part	Fix part	Loose part	Fix part	Loose part
Data transmission	Profinet/Industrial Ethernet	Profinet/Industrial Ethernet	Profibus	Profibus	IO-Link	IO-Link
Data rate	100	100	12	12	-	-
Fixing thread	M12	M12	M12	M12	M12	M12
Weight [kg]	0.11	0.11	0.13	0.12	0.11	0.11

▶ ADAPTER PLATES

Order no.	▶ Technical Data	
	APWER3052	APWER3054
compatible with	2xWER3000	4xWER3000
Weight [kg]	0.07	0.13

▶ TECHNICAL INFORMATION



▶ Information about round plugs and plug-in connectors for the WER3000 is provided on page 63





PLUG-IN CONNECTOR FOR ENERGY ELEMENTS

SUITABLE FOR WER201 / WER02 / WER03 / WER3000





▶ PLUG-IN CONNECTOR FOR ENERGY ELEMENTS WER201 / WER02 / WER03

Order no.	▶ Technical Data							
	KAG500B4	KAW500B4	B8-G-4	B8-W-4	KAG500S4	KAW500S4	S8-G-4	S8-W-4
Fixing thread	M8	M8	M8	M8	M8	M8	M8	M8
No. of contacts	4	4	4	4	4	4	4	4
Cable length [m]	5	5	-	-	5	5	-	-
Cable-Ø [mm]	4.3	4.3	-	-	4.3	4.3	-	-
Cable sheath material	PUR	PUR	-	-	PUR	PUR	-	-
Bend radius	10xØ	10xØ	-	-	10xØ	10xØ	-	-
Protection to IEC 60529	IP67	IP67	IP67	IP67	IP67	IP67	IP67	IP67
Connection type	Female	Female	Female	Female	Connector	Connector	Connector	Connector
Version [Type]	Straight	Angle	Straight	Angle	Straight	Angle	Straight	Angle

▶ ROUND PLUG FOR WER3000

Order no.	▶ Technical Data			
	RSTVLM23G06B-B	RSTVLM23W06B-B	RSTVLM23G06S-B	RSTVLM23W06S-B
Fixing thread	M23	M23	M23	M23
No. of contacts	6	6	6	6
Protection to IEC 60529	IP67	IP67	IP67	IP67
Connection type	Socket	Socket	Male	Male
				

Order no.	▶ Technical Data			
	RSTVLM23G08B-B	RSTVLM23W08B-B	RSTVLM23G08S-B	RSTVLM23W08S-B
Fixing thread	M23	M23	M23	M23
No. of contacts	8	8	8	8
Protection to IEC 60529	IP67	IP67	IP67	IP67
Connection type	Socket	Socket	Male	Male
				

Order no.	▶ Technical Data			
	RSTVSM23G12B-B	RSTVSM23W12B-B	RSTVSM23G12S-B	RSTVSM23W12S-B
Fixing thread	M23	M23	M23	M23
No. of contacts	12	12	12	12
Protection to IEC 60529	IP67	IP67	IP67	IP67
Connection type	Socket	Socket	Male	Male
				

Order no.	▶ Technical Data			
	RSTVSM23G19B-B	RSTVSM23W19B-B	RSTVSM23G19S-B	RSTVSM23W19S-B
Fixing thread	M23	M23	M23	M23
No. of contacts	19	19	19	19
Protection to IEC 60529	IP67	IP67	IP67	IP67
Connection type	Socket	Socket	Male	Male
	