

ROTARY DISTRIBUTORS

SERIES DVR

▶ PRODUCT ADVANTAGES



▶ **Compact media transfer system**

This D1 media exchanger makes cable breaks and undefined interference contours through the power supply line a thing of the past

▶ **Flat design**

This structure reduces the moment load for your robot to a minimum and makes it possible to use smaller and more affordable sizes

▶ **Gold contact**

Allows flexibility for transmission because you can transfer everything from the smallest flows up to 250 volts and 6 amps with process reliability

▶ THE BEST PRODUCT FOR YOUR APPLICATION



▶ **Our products welcome the challenge!**

Extreme conditions, all over the world—our tried and tested components and systems give you endless possibilities.

Find the best product for your specific use:

www.zimmer-group.com

► **BENEFITS IN DETAIL**

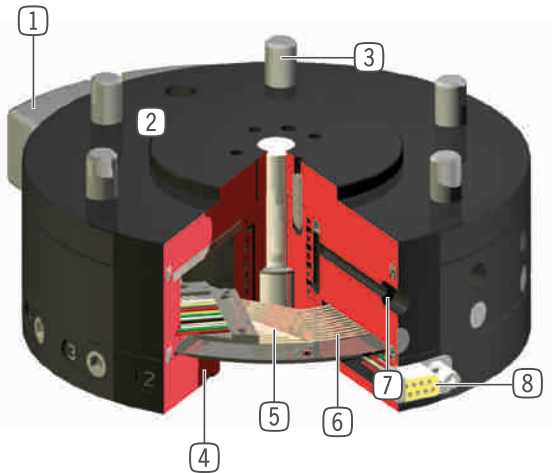

- ① **Torque brace**
- supports the rotor during rotation (movement)
- ② **Robust, lightweight housing**
- Hard-coated aluminum alloy
- nitrated steel
- ③ **Robot flange**
- partial mounting circle in accordance with EN ISO 9409-1
- ④ **Direct air connection**
- to WWR series
- ⑤ **Spring system**
- from size DVR63 double fitting
- ⑥ **Collector ring**
- hard gold coated
- transferable to finest currents
- ⑦ **Up to 8 way integrated air feed-through**
- for hoseless air transfer
- hose package does not have to be pivoted
- ⑧ **Up to 12 pole energy transfer**
- for cable-free signal transfer
- no cables are subjected to torsion

► **FURTHER INFORMATION IS AVAILABLE ONLINE**



► **Technical Information**

All information just a click away at: www.zimmer-group.com
Find data, illustrations, 3D models and operating instructions for your installation size using the order number for your desired product.
Quick, clear and always up-to-date.



ROTARY DISTRIBUTORS

INSTALLATION SIZE DVR50

▶ PRODUCT SPECIFICATIONS



▶ Forces and moments

Shows static forces and moments which may impact on the rotary distributor.

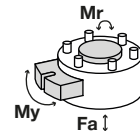

Mr [Nm]	60
My [Nm]	60
Fa [N]	800

▶ INCLUDED IN DELIVERY



Cylinder Screw

C7984060129



O-Ring

COR0025100

▶ RECOMMENDED ACCESSORIES



Straight Fittings - Quick Connect Style

GVM5



Angled Fittings - Quick Connect Style

WVM5



Plug-in connector Angled Cable 5m - Socket M8 (female)

KAW500B4



Plug-in Connector Angled Cable 5m - Connector M8

KAW500S4



Plug-in connector Straight Cable 5m - Socket M8 (female)

KAG500B4



Plug-in Connector Straight Cable 5m - Connector M8

KAG500S4

► Technical Data	
Order no.	DVR50I4
Connecting flange according EN ISO 9409-1	TK 50
Recommended handling weight [kg]	15
Pneumatic energy transfer [Quantity]*	4
Electrical energy transfer	4-pole
Max. current [A]	3
Max. voltage [V]	24
Maximum acceleration [m/s ²]	22
Maximum speed [1/min.]	120
Maximum speed [°/s]	720
Radial run out +/- [mm]	0.02
Axial run out +/- [mm]	0.02
Constant torque [Nm]	1
Loose torque [Nm]	1.5
Operating pressure max. [bar]	10
Operating temperature [°C]	5 ... +80
Moment of inertia [kg/cm ²]	8.1
Protection to IEC 60529	IP40
Weight [kg]	0.6

*Vacuum possible

