

FLAT SWIVEL UNITS

SERIES DES

▶ PRODUCT ADVANTAGES

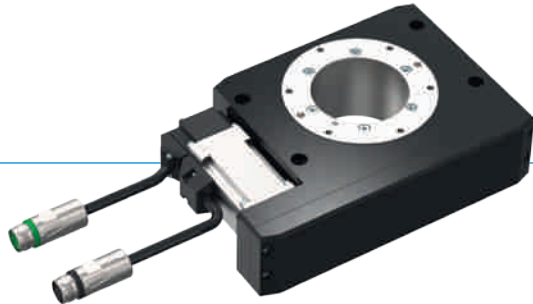

“The unique”

▶ Decide for yourself!

With the standard motor or motors from another manufacturer - You decide what harmonises the best with your system

▶ Integrated media transmission

The D1 media exchanger makes cable breaks and undefined interference contours through the power supply line a thing of the past

▶ Freely positionable

No matter whether your task involves rotating, lifting or cycling: The unit is universally usable and can be uniquely adjusted to your application

▶ BENEFITS IN DETAIL

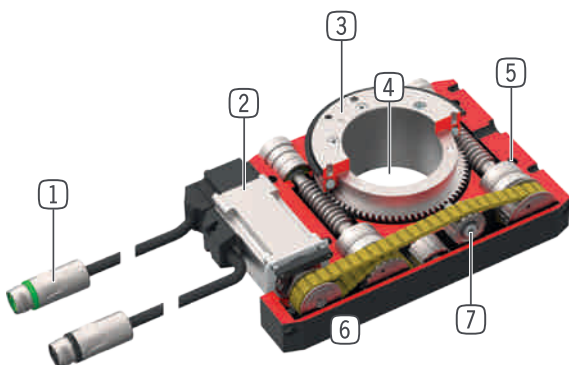

① Energy supply

- motor cable, female
- encoder cable, male

② Drive

- AC servo motor

③ Intake flange

- for connection to application-specific adapter plate (to be produced by the customer)
- simple tool connection

④ Central bore

- for cable feed-through

⑤ Mounting and positioning

- mounting possible from several sides for versatile positioning

⑥ Robust, lightweight housing







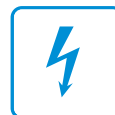





- Hard-coated aluminum alloy

⑦ Force transfer

- tooth belt/gear rack/worm gear



► SERIES CHARACTERISTICS

Installation size		Version		
DESXXX		-B	D1-B	-99
 PB	Profibus	•	•	
 PN	Profinet, EtherCat, EtherNet/IP, Sercos	•	•	
 M	with drive	•	•	
 X	unpowered; installation provided by customer			•
 5 Mio	5 million maintenance-free revolutions (max.)	•	•	•
 L	Self locking mechanism	•	•	•
 IP 54	IP54	•	•	•
 S	Integrated sensing	•	•	
 CVP	Continuously variable positions	•	•	
 SA	Adjustable swivel angle	•	•	
 E	Electrical feed-through		•	
 F	Fluid feed-through		•	

► TECHNICAL DATA

Installation size	Swivel angle [°]	Torque [Nm]	Weight [kg]	IP class
DES140	∞	10 - 12	4 - 7	IP54
DES190	∞	62 - 64	10,8 - 15,9	IP54

► FURTHER INFORMATION IS AVAILABLE ONLINE



All information just a click away at: www.zimmer-group.com. Find data, illustrations, 3D models and operating instructions for your installation size using the order number for your desired product. Quick, clear and always up-to-date.

FLAT SWIVEL UNITS

INSTALLATION SIZE DES140

▶ PRODUCT SPECIFICATIONS



▶ Forces and moments

Indicates the static load on the bearing.

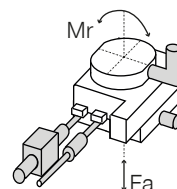

Fa [N]	7000
Mr [Nm]	400

▶ INCLUDED IN DELIVERY



1 [piece]
Commissioning USB
052650

▶ RECOMMENDED ACCESSORIES



ENERGY SUPPLY



ZUBHCS-B
Drive controller Profibus



ZUBHCSME-B
Drive control unit SERCOS III, PROFINET IO, EtherNet/IP, EtherCAT



ZUBHCSN
Line filter



CONNECTIONS / OTHER



ZUBHCSS
Indra Works Drive Start Up CD



ZUBHCSKAG05-B
Encoder cable 5 m



CONNECTIONS / OTHER



ZUBHCSKAG10-B
Encoder cable 10 m



ZUBHCSKAG25-B
Encoder cable 25 m



ZUBHCSKAP01
Programming cable



ZUBHCSKAL05-B
Power cable 5 m



ZUBHCSKAL10-B
Power cable 10 m



ZUBHCSKAL25-B
Power cable 25 m

Order no.	► Technical data	
	DES140-B	DES140-99
Drive *	AC servo motor	Specific to the customer
Rotation angle [°]	unlimited	
Nominal torque [Nm]	9	
Torque max. [Nm]	12	
Nominal speed [rpm]	30	
Max. speed [rpm]	50	
Swivel time 360° with 30 rpm [s] **	2.5	
Swivel time 360° with 50 rpm [s] **	1.8	
Moment of inertia max. [kg m ²]	1	
Jaw speed in positioning mode [rad/s ²]	50	
Positioning delay [rad/s ²]	50	
Electrical energy transfer		
Pneumatic energy transfer [Quantity]		
Self locking mechanism	Helical gear / worm gear	Helical gear / worm gear
Power transfer	Helical gear / worm gear	Helical gear / worm gear
Repetition accuracy +/- [°]	0.1	0.1
Operating temperature [°C]	5 ... +80	5 ... +80
Net input voltage	1x200-240 VAC 50HZ	
Continuous current [A]	0.9	
Peak current [A]	3	
Protection to IEC 60529	IP54	IP54
Weight [kg]	4.2	4

*Select the third-party motor corresponding to the motor performance figures in the DES series - Accessories chapter

**Swivel time does not depend on the moment of inertia (the maximum moment of inertia must not be exceeded)

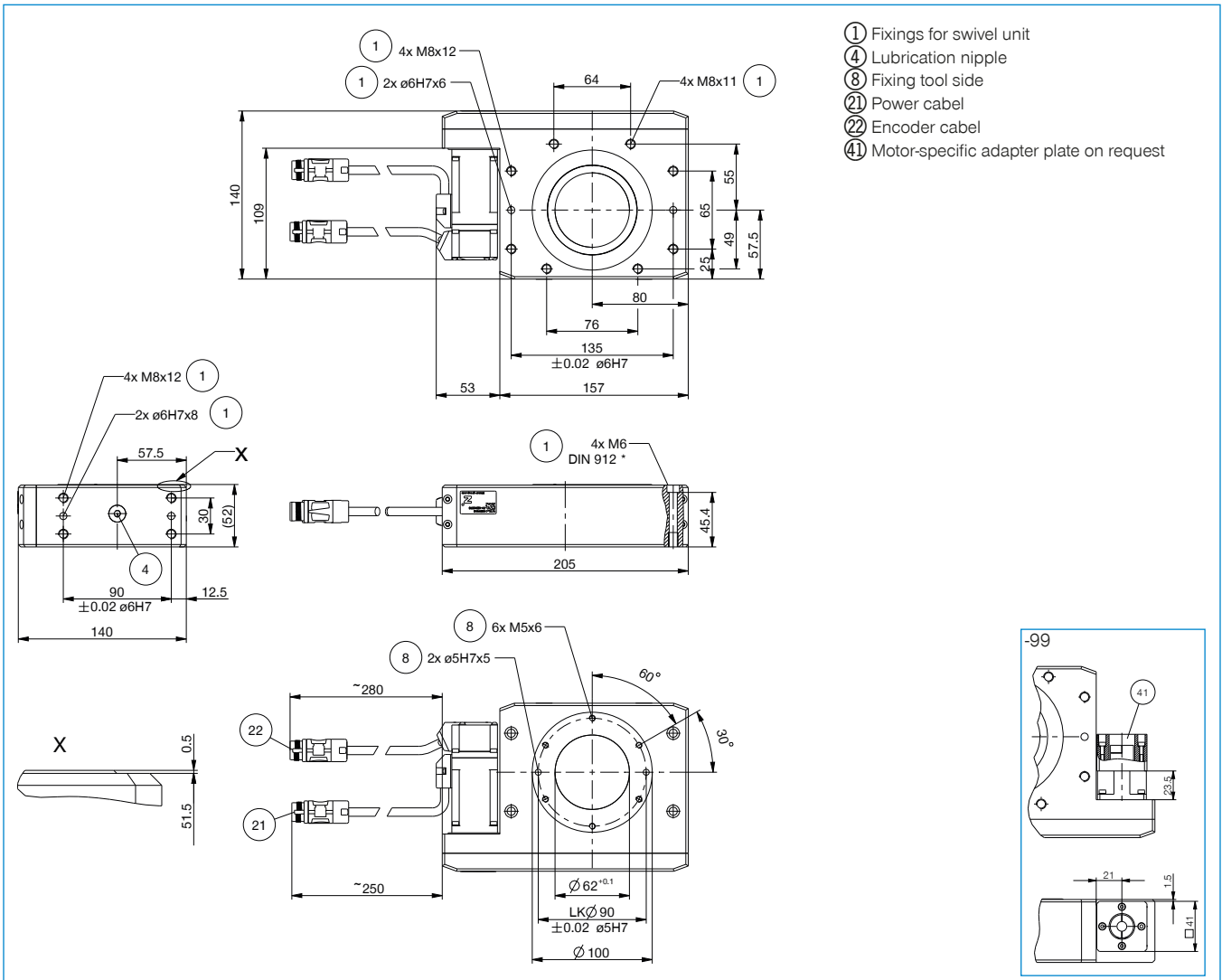

FLAT SWIVEL UNITS

DES SERIES - ACCESSORIES

▶ RECOMMENDED ACCESSORIES



ENERGY SUPPLY



ZUBHCS-B
Drive controller Profibus



ZUBHCSME-B
Drive control unit SERCOS III, PROF-INET IO, EtherNet/IP, EtherCAT



ZUBHCSN
Line filter



GV1-4X8
Straight Fittings - Quick Connect Style



WV1-4X8
Angled Fittings - Quick Connect Style



CONNECTIONS / OTHER



ZUBHCSS
Indra Works Drive Start Up CD



ZUBHCSKAG05-B
Encoder cable 5 m



ZUBHCSKAG10-B
Encoder cable 10 m



ZUBHCSKAG25-B
Encoder cable 25 m



ZUBHCSKAP01
Programming cable



ZUBHCSKAL05-B
Power cable 5 m



ZUBHCSKAL10-B
Power cable 10 m



ZUBHCSKAL25-B
Power cable 25 m



RSTVSM23G12S-B
Round plug, straight - M23 plug



RSTVSM23W12S-B
Round plug, angular - M23 plug



RSTVSM23G12B-B
Round plug, straight - M23 socket



RSTVSM23W12B-B
Round plug, angular - M23 socket

► **Technical data for motors**

Order no.	MSM019B-0300-NN-M5-MH0	MSM031C-0300-NN-M5-MH0
compatible with	DES140	DES190
Manufacturer	BOSCH	BOSCH
Nominal torque [Nm]	0,32	1,3
Torque max. [Nm]	0,95	3,8
Nominal speed [rpm]	3000	3000
Max. speed [rpm]	5000	5000
Protection to IEC 60529	IP54	IP54

